

型号

EPC-1702

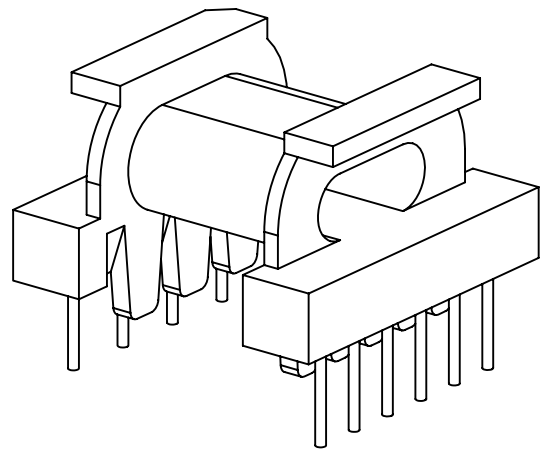
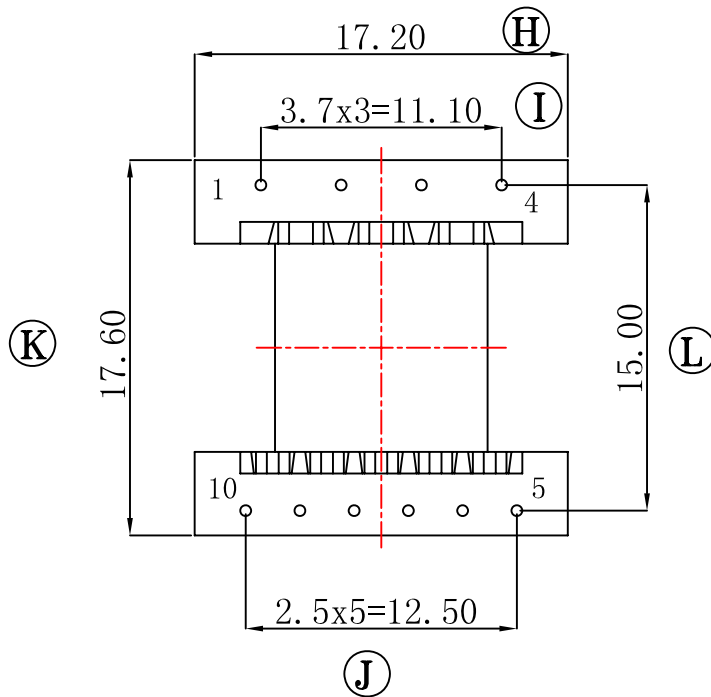
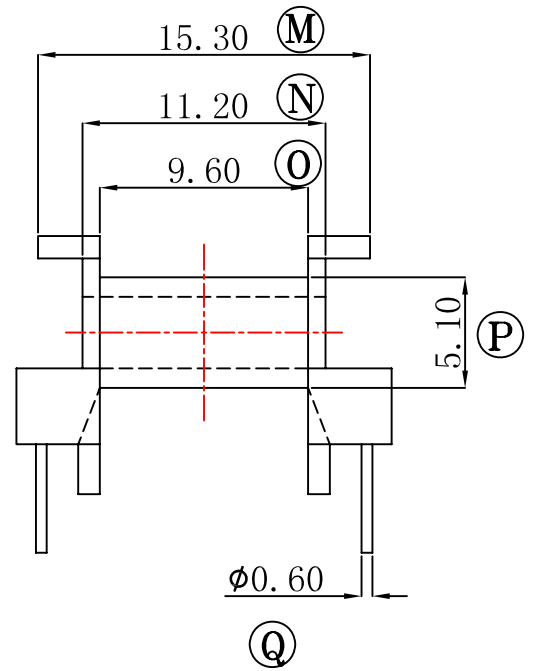
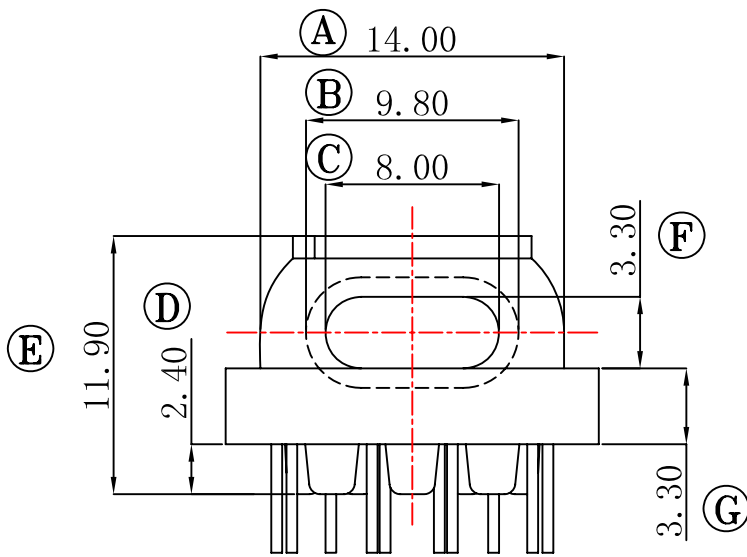

REV	DATE	REVISIONS	REC

深圳市捷达成电子有限公司

SHENZHEN JIE DA CHENG ELECTRONICS CO.,LTD.

TEL:0755-27317730 FAX:0755-27317731

ANGLE:
+/-1°

MODEL NAME:
EPC-1702 4+6PIN

UNIT:
MM

UL REC:
UL 94V-0

BOBBIN MATERIAL:
PHENOLIC

DRAFTER L.R.J

TOLERANCE

SCALE:
4/1

PIN TENSION LOAD:
1.0KG MIN

PIN MATERIAL:
CP WIRE

CHECKER Y.F.

0<L<4 ±0.1
4<L<16 ±0.2
16<L<50 ±0.3
PIN PITCH ±0.2

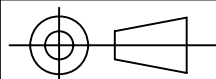

DATE:
2012-06-15

DRAWING NO:
EPC-1702

REV:
1.0